

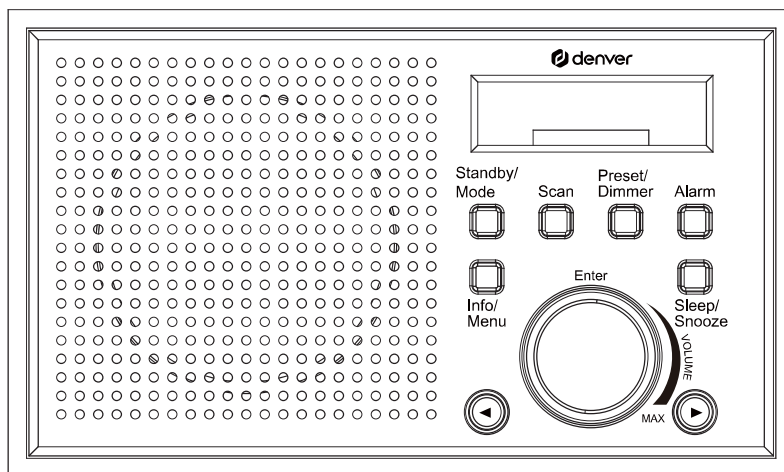

Instruction manual



DAB-46

www.denver.eu

04/2026



FR

Cet appareil et ses cordons sont recyclables

À DÉPOSER EN MAGASIN



À DÉPOSER EN DÉCHÈTERIE



OU

Points de collecte sur www.quefairedemesdechets.fr
Privilégiez la réparation ou le don de votre appareil !

DAB Radio Signal

Please notice that DAB signal can be weakened MUCH depending on the type of building you are living in. (fx. It can be hard to catch proper signal when being in a concrete building.)

Signal can also be different in different areas of the country.

Please check your local transmitter to get the best signal in your area.

Safety information

Please read the safety instructions carefully before using the product for the first time and keep the instructions for future reference.

1. This product is not a toy. Keep it out of reach of children.
2. Keep product out of the reach of children and pets to avoid chewing and swallowing.
3. Never use old and new batteries or different types of batteries together. Remove the batteries when you are not using the system for a longer period of time. Check the polarity (+/-) of the batteries when inserting them in the product. Wrong positioning can cause an explosion. Batteries are not included.
4. Product operating and storage temperature is from 0 degree Celsius to 40 degree Celsius. Under and over this temperature might affect the function.
5. Never open the product. Touching the inside electrics can cause electric shock. Repairs or service should only be performed by qualified personnel.
6. Do not expose to heat, water, moisture, direct sunlight!
7. Please protect your ears against loud volume. Loud volume can damage your ears and risk in hearing loss.
8. The unit is not waterproof. If water or foreign objects enter the unit, it may result in fire or electric shock. If water or a foreign object enters the unit, stop use immediately.
9. Only charge with supplied Adaptor. The direct plug-in adaptor is used as disconnect device, the disconnect device shall remain readily operable. So, make sure there is space around the power outlet for easy access.
10. Do not use non original accessories together with the product as this can make the product functionality abnormal.

PRODUCT OVERVIEW

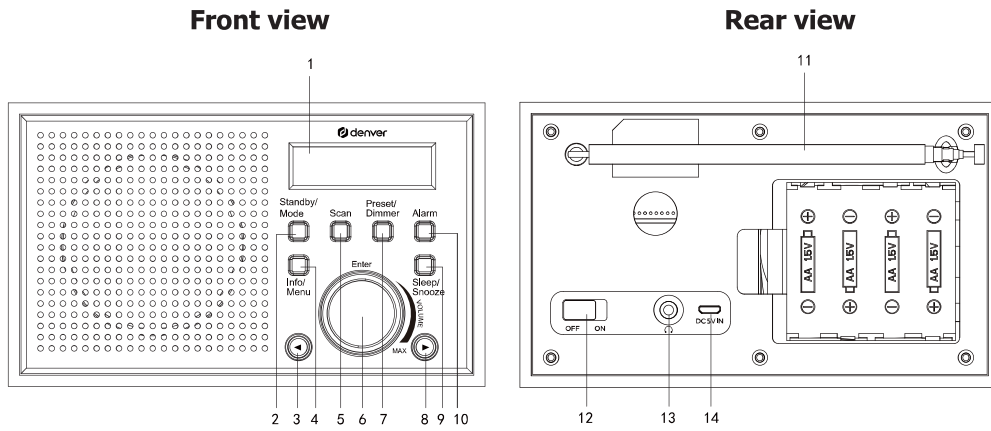

1. LCD DISPLAY
2. STANDBY/MODE BUTTON
3. PREVIOUS BUTTON
4. INFO/MENU BUTTON
5. SCAN BUTTON
6. ENTER/VOLUME KNOB(Confirm the setting/adjust the button)
7. PRESET/DIMMER BUTTON
8. NEXT BUTTON
9. SLEEP/SNOOZE BUTTON
10. ALARM BUTTON
11. ANTENNA
12. OFF/ON BUTTON
13. HEADPHONE JACK
14. DC 5V IN
15. AC/DC ADAPTOR



BASIC OPERATION - GETTING STARTED

The unit can be powered either by AC power or battery.(not incl)

Operation on AC power

1. Insert the DC power jack of AC/DC adaptor to the DC input socket located at the rear of the radio.
2. Plug the AC/DC adaptor to the AC mains outlet.
3. Slide the **ON/OFF** switch to **ON** and press the **STANDBY/MODE** button to turn the radio on.

Warning: Always use the supplied AC power adapter. If the AC Adaptor voltage is more than 5V, product damage or risk possibly occurs.

Operation on battery

1. Ensure the AC/DC adaptor is disconnected from the unit.
2. Load 4 AA batteries in the battery compartment.
3. Press the **STANDBY/MODE** button to turn the radio on.

Note: To obtain the best performance on battery operation, use of alkaline batteries is highly recommended.

Navigation of the menu

The following controls are used to move about the menu tree to choose and select the required settings:

Press and hold the **INFO/MENU** button to enter the menu options. Press the ◀ or ▶ button to navigate the options, then press the **ENTER/VOLUME** knob to confirm.

Description of the menu

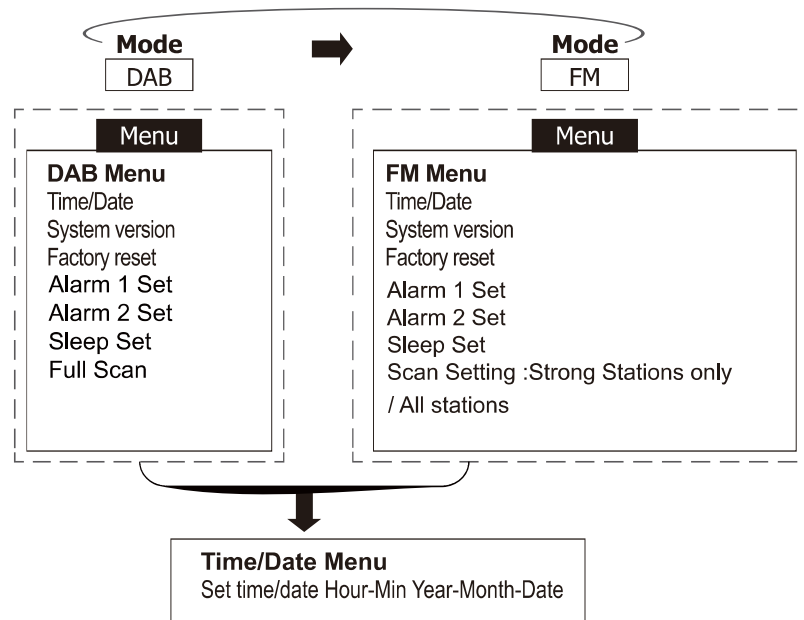

OPERATION OF RADIO

DAB radio

Press the **STANDY/MODE** button to turn the unit on, and press the **SCAN** button to search for all available radio stations. During the scan, the display show "Full scan" together with a slide bar that indicates the progress of the scan and the number of stations that have been found so far (Fig.2).

Once the scan has finished, the radio broadcasts the first alphanumerically found station. You can now press the ◀ / ▶ buttons to select the found stations, then press the **ENTER/VOLUME** knob to confirm selection.

Note: If there is no station found after auto scan, the radio will display "No Station". In this case, adjust the position of the antenna and relocate the unit for better signal reception.

Fig.1



Fig.2



FM radio

1. To select FM, press the **STANDBY/MODE** button. The display shows FM and the frequency.
2. To activate auto search, press and hold the **SCAN** button until the radio starts to scan. The scan stops automatically once a FM station has been found.
3. To search manually, press repeatedly the ◀ / ▶ button to tune to a radio station. If the reception is poor, adjust the position of the antenna and relocate the unit for better signal reception.

FM scan via menu

In **FM** mode, press and hold the **INFO/MENU** button to enter the menu, and press the ◀ / ▶ button to select “FM scan setting” (Fig.3), then press the **ENTER/VOLUME** knob to enter the sub-option. Then press the ◀ / ▶ button to select “Only<All>” (Fig.4), and press the **ENTER/VOLUME** knob to confirm selection for FM scanning.

Fig.3

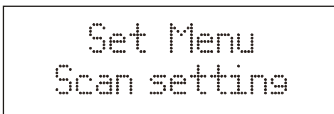
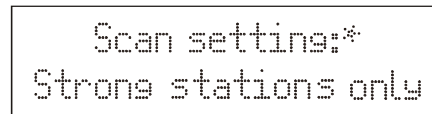



Fig.4



USING HEADPHONES

A stereo headphone jack is available on the unit. Plug your earphones or headphones (not supplied) to the jack marked , and adjust the volume to the reasonable listening level. The speakers of the unit are disabled for output while earphones or headphones are inserted.

Warning: Excessive sound pressure from earphones or headphones can cause hearing loss.

RESET

If you move the unit to another location or another country, the stored DAB stations may no longer be available. In this case, reset the unit to the factory settings.

1. With the unit switched on, press and hold the **INFO/MENU** button to enter the menu, and press the ◀ / ▶ button to select “Factory reset” (Fig.5) , then press the **ENTER/VOLUME** knob to enter the sub-option. Then press the ◀ / ▶ button to select “<Yes>” from the “Factory Reset <No> Yes” option (Fig.6), and press the **ENTER/VOLUME** knob to confirm.
2. The radio displays “Restarting....”, and start searching all available radio stations.

Note: All the previously stored radio stations are deleted after resetting.

Fig.5

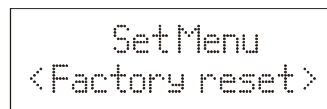
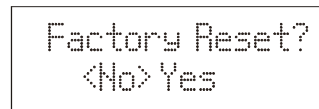

Fig.6



TECHNICAL SPECIFICATIONS

Manufacture	Shenzhen Adition Audio Science & Technology Co., Ltd
Brand	Adition
Business registration no	914403007604818396
Address	No.2 Building , Huidebao Industrial Park, Baihua Community, Guangming ,Guangming District, Shenzhen , 518107, China
Model no	AD0600501000EU-MICROUSB
Input	100-240~50/60Hz, 0.2A Max
Output	5.0V-1.0A 5.0W
Average active efficiency	75.26%
No-load power consumption	0.07W
Audio output	2 W RMS
Radio	DAB 174-240MHz FM 87.5-108MHz
Operating conditions Temperature	5°C to 35°C Humidity 5% to 90%
Unit dimension	170 (L) × 96(W) × 101 (H) mm
Weight	0.7kg

SPECIFICATION SUBJECT TO CHANGE WITHOUT FURTHER NOTICE.

Please notice - All products are subject to change without any notice. We take reservations for errors and omissions in the manual.

ALL RIGHTS RESERVED, COPYRIGHT DENVER A/S



Electric and electronic equipment contains materials, components and substances that can be hazardous to your health and the environment, if the waste material (discarded electric and electronic equipment) is not handled correctly.

Electric and electronic equipment is marked with the crossed out trash can symbol, seen above. This symbol signifies that electric and electronic equipment should not be disposed of with other household waste but should be disposed of separately.

All cities have established collection points, where electric and electronic equipment can either be submitted free of charge at recycling stations and other collection sites or be collected from the households. Additional information is available at the technical department of your city.

Hereby, Denver A/S declares that the radio equipment type DAB-46 is in compliance with Directive 2014/53/EU. The full text of the RED declaration of conformity is available at the following internet address: denver.eu and then click the search ICON on topline of website. Write model number: DAB-46. Now enter product page, and RED directive is found under downloads/other downloads.

Information on standby/off mode power consumption and power management for products compliant with Commission Regulation (EU) 2023/826 can be found at the following internet address: denver.eu and then click the search ICON on topline of website. Write model number: DAB-46 and enter the page.

Max audio output power: 5W RMS
FM radio operating frequency range: 87.5-108MHz
DAB radio operating frequency: 174 – 240MHz

DENVER A/S
Omega 5A, Soeften
DK-8382 Hinnerup
Denmark
www.denver.eu
www.facebook.com/denver.eu

Contact

Main contact point: contact.hq@denver.eu

Nordics

Headquarter

Denver A/S
Omega 5A, Soefthen
DK-8382 Hinnerup
Denmark

Phone: **+45 86 22 61 00**
(Push "1" for support)

E-Mail

For technical questions, please write to:
support.hq@denver.eu

For all other questions please write to:
contact.hq@denver.eu

Benelux

DENVER BENELUX B.V.

Barwoutswaarder 13C+D
3449 HE Woerden
The Netherlands

Phone: **0900-3437623**
E-Mail: **support.nl@denver.eu**

Spain/Portugal

DENVER SPAIN S.A

Ronda Augustes y Louis Lumiere, nº 23 – nave
16
Parque Tecnológico
46980 PATERNA
Valencia (Spain)

Spain

Phone: **+34 960 046 883**
Mail: **support.es@denver.eu**

Portugal:

Phone: **+35 1255 240 294**
E-Mail: **denver.service@satfiel.com**

Germany

Denver Germany GmbH Service

Service Center
Max-Emanuel-Str. 4
94036 Passau

Phone: **+49 851 379 369 40**

E-Mail

support.de@denver.eu

Monday - Thursday 09:00 - 16:30
Friday 09:00 - 14:00

Austria

Lurf Premium Service GmbH
Deutschstrasse 1
1230 Wien

Phone: **+43 1 904 3085**
E-Mail: **denver@lurfservice.at**

Poland

LetMeRepair Poland sp. z o.o.

ul. Częstochowska 140
62-800 Kalisz

Phone: **62 75 38 092**
E-Mail: **denver-service@letmerepair.pl**

Godziny pracy: 8 – 18 (poniedziałek – piątek)

If your country is not listed above,
please write an email to
contact.hq@denver.eu



Denver A/S
Omega 5A, Soefthen
DK-8382 Hinnerup
Denmark

denver.eu
facebook.com/denver.eu

